

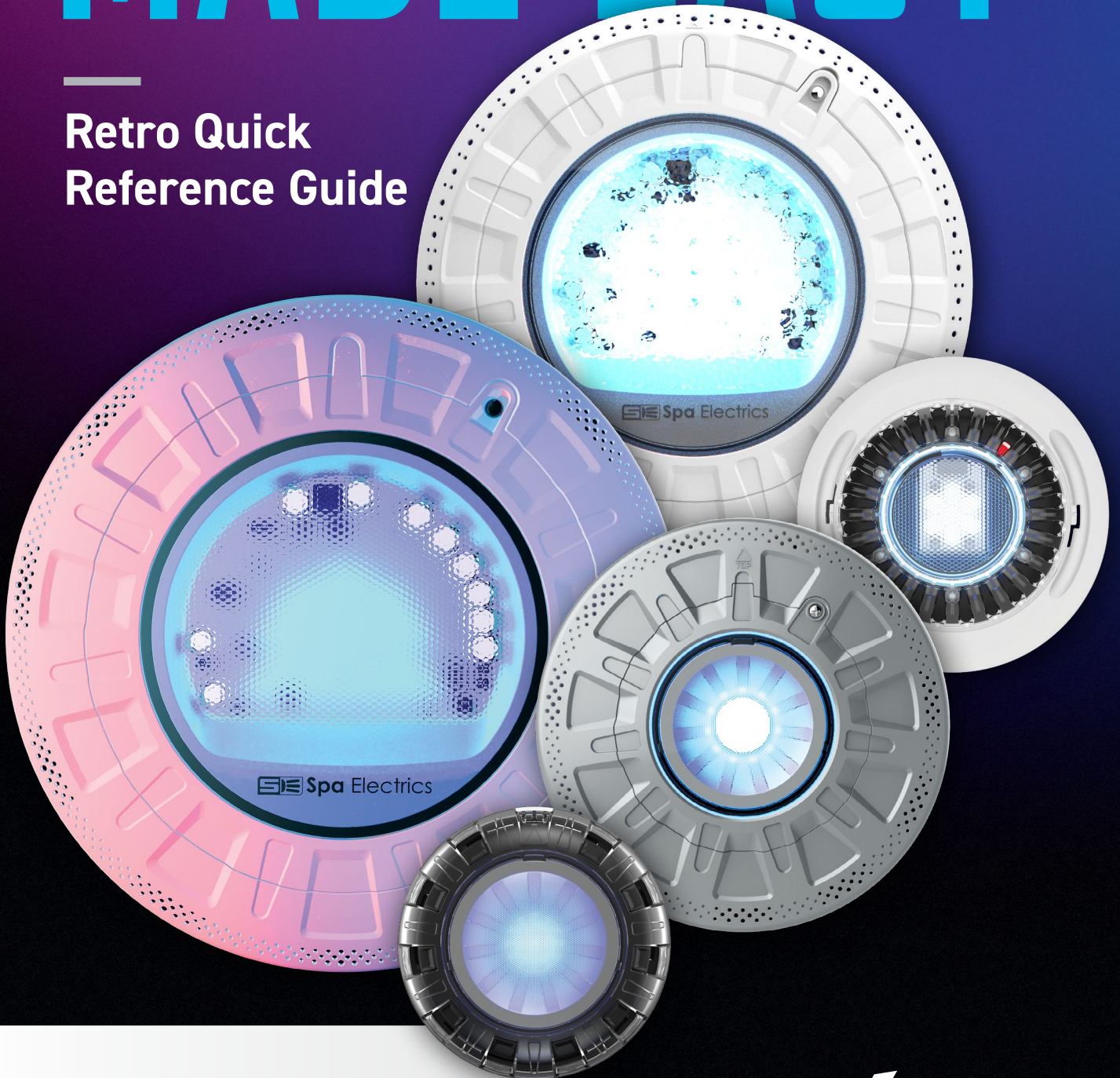



# LIGHT REPLACEMENT MADE EASY

Retro Quick  
Reference Guide



 Spa Electric<sup>®</sup>

spaelectrics.com |    

*retro*<sup>®</sup>

REPLACEMENT LED POOL LIGHT

# PRE-INSTALLATION CHECK

## 1. CHECK POWER SUPPLY

A 12V AC Transformer **MUST** be installed between the 120V power supply and pool light. Do **NOT** continue installation if directly connected to 120V power.

DO **NOT** CONTINUE INSTALLATION IF DIRECTLY CONNECTED TO 120V POWER.

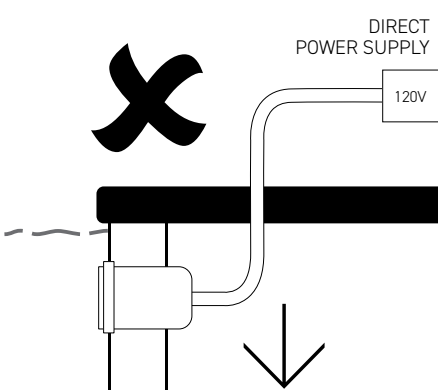

IF THERE IS AN EXISTING TRANSFORMER, CHECK THAT IT MEETS THE SPECIFICATIONS LISTED BELOW IN STEP 2.

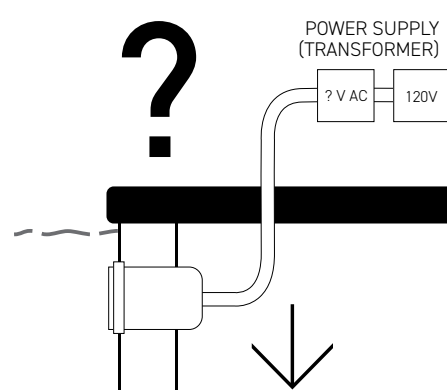

## 2. ADD A TRANSFORMER

TRANSFORMER REQUIRED SPECIFICATION:

- UL Listed Isolating Low Voltage power supply, evaluated for swimming pool use
- Installed as per current NEC wiring rules
- 12-14V AC output
- Minimum Wattage requirement per light. See Step 2a
- In good working order

TRANSFORMER MUST **NOT** BE:

- DC or 'LED Driver'
- Electronic or Switch mode
- Weather damaged or in otherwise poor condition

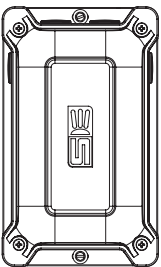

Spa Electrics recommends “**LVX**” safety transformers or LITYARD Control System for use with **Retro Universal** lights.

Available Models:

LVX50  
LVX50P  
LVX100  
LVX100P  
LITY2XRFHCA

## 2a. WATTAGE REQUIREMENT

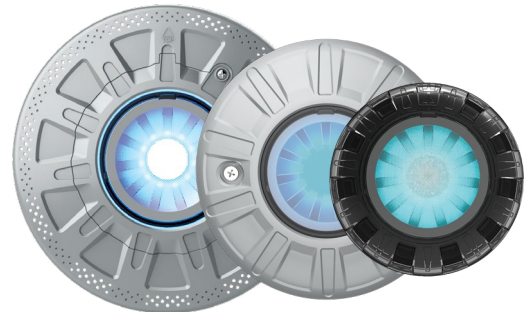

R6, R1, EMRX: 15W PER LIGHT

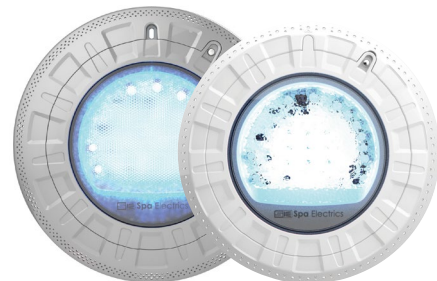

R10, R8: 45W PER LIGHT

### 3. CHECK CABLE THICKNESS

Retro Universal can fit cables from 9/32" (7mm) up to 9/16" (14mm) diameter



### 4. CHECK BONDING

Ensure bonding is secure at the back of the niche.

**DO NOT CUT** the bonding cable. **DO NOT DISTURB** the bonding cable when working with the plug cable.

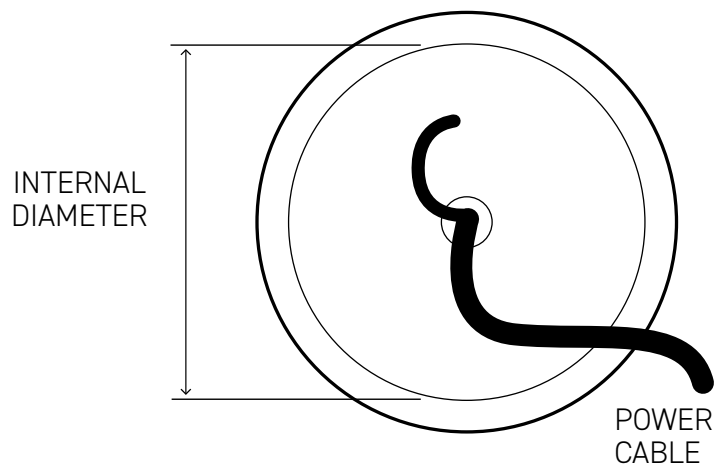
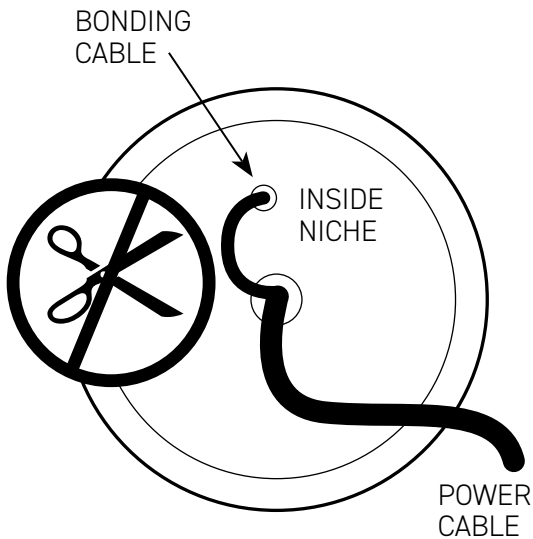

### 5. CHECK NICHE DIAMETER

Retro Universal lights are designed to work with various diameter niches. Please refer to the table below for niche/pipe diameter and the recommended Retro Fit options.

NICHE DIAMETER AND RETRO-FIT OPTION		
Niche/Pipe Diameter (inch)	Minimum Niche Depth	Recommended Retro-Fit
9.05" - 9.6"	3.4"	<b>R10</b>
Hayward LFGUY Shallow Niche		<b>R10H</b>
7.5" - 8.25"	4.0"	<b>R8</b> with standard Cam Locks
8.6" - 9.64"	4.4"	<b>R8</b> with Q500 Cam Locks (sold separately)
4.75" - 5.2"	4.7"	<b>R6</b> with standard Cam Locks
5.8" - 6.5"	5.0"	<b>R6</b> with Q500 Cam Locks (sold separately) - PN: R6C 006 Q5 CA
1.5" thread fitting		<b>R1 C1</b>
PAL Threaded Niche		<b>R1 C2</b>

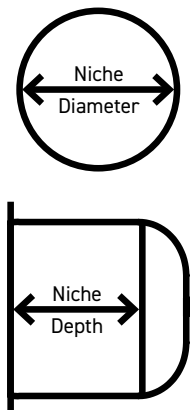

# EMRX RETRO FITS

[Click here for full instructions](#)

## SERIES FOR EXISTING AQUA/LAMP®

LIGHTS & MOUNTING KIT		
Pool Type	LED Option	Product Code
CONCRETE & VINYL POOLS	1x EMRX Multi Plus Light & Grey Aqualamp Adaptor	EMRX L12 R2 GMPL
	1x EMRX Multi Plus Light & White Aqualamp Adaptor	EMRX L12 R2 WMPL

EMRX RETRO FITS WITH AQUA/LAMP®	
Light Model	Dimension
Aqua/Lamp® (Verified)	1.5" diameter 5 1/2" long



# R1 RETRO FITS



## SERIES 1.5" THREADED RETRO LIGHTS

LIGHTS & MOUNTING KIT			
Pool Type	LED Option	Rim Colour	Product Code
<b>CONCRETE &amp; VINYL POOLS</b>			
X1 Argon Light + Adaptor Plate + Plug Kit	Multi Plus	Clear	<b>R1 L12 C1 CMP</b>

REPLACEMENT BULBS INCLUDES 1X 6" LIGHT			
Pool Type	LED Option	Rim Colour	Product Code
<b>CONCRETE &amp; VINYL POOLS</b>			
1x Argon Light + Clear Rim	Multi Plus	Clear	<b>N3 L12 C0 CMP</b>

### R1 RETRO FITS WITH THREADED 1.5 INCH FITTING BRACKET

Light Model	Dimension
Jandy WaterColors Nicheless LED lights (not if using vinyl/fibreglass GloBrite niche)	1.5" diameter 5 1/2" long
Hayward Return Light (Colour Logic or Crystal Logic) *Must be installed in a threaded return fitting	1.5" fitting
MicroBrite® Color and White LED Lights	1.5" fitting
BRIO LED Light 3"	1.5" return fitting
MINI-BRIO Mini LED Light	1.5" return fitting
SAVI Note NEXXUS LED Underwater Nicheless Pool Light	1-1.5" fitting
CMP Brilliant Wonders® 1.5" LED Light	1.5" fitting 4-4.5" depth
S.R Smith Micro LED Pool Light (only if the light fitting has not been removed)	1.5" PVC custom fitting which is supplied with the light

Will fit existing 1.5" threaded fittings. Examples:



# R6 RETRO FITS



## SERIES 6" RETRO LIGHTS

### LIGHTS & MOUNTING KIT CHOOSE YOUR LIGHT OPTION, UNIVERSAL ADAPTOR & RIM COLOR

Pool Type	LED Option	Rim Colour	Product Code
CONCRETE & VINYL POOLS 1x Retro 6" (R6) Light + 6" Niche Adaptor + Plug Seal Assembly + Rim	Multi Plus	White	R6C L12 C1 WMP
		Grey	R6C L12 C1 GMP

Will fit existing niches with inner diameter of:

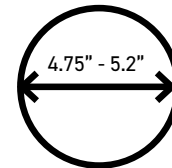

(Standard Kit)

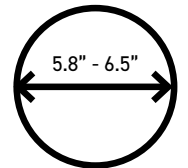

(With R6006Q5CA Cam-Locks)

### REPLACEMENT BULBS INCLUDES 1X 6" LIGHT

Pool Type	LED Option	Product Code
CONCRETE & VINYL POOLS	1x Argon 3" Multi Plus Light	N3 L12 C0 CMP

### R6 WITH STANDARD R6 BRACKET

Light Model	Dimension	Spare Part
Pentair Plastic Niche (Small) 79206600	5.3"	
Pentair Sta-Rite Sunlite 05607		
Jandy ProNiche PL - Small, PLNICSM -	5.2"	
Hayward ULC Series Underwater Small Lighting Niche	6.5"	
Hayward DuraNiche™ SP0607U, SP0608U and SP0601U	4.6"	R6 Vinyl Dress Ring
Hayward AstroLite™ II Series Spa Lighting SP0590 series	5 3/4" (outside diameter of face rim)	



#### Part Numbers for Vinyl Dress Rings:

R6V0021CAWH - White

R6V0021CAGY - Grey

# R6 RETRO FITS (CONTINUED)

## SERIES 6" RETRO LIGHTS

R6 WITH STANDARD R6 BRACKET	
Light Model	Dimension
Hayward AstroLite™ II Series Spa Lighting SP0590 series	5 7/8" (outside diameter of face rim)
Hayward ColorLogic 4.0 LED Pool & Spa Lights	N/A
IntelliBrite® 5G Color and White LED Pool Lights	6"
Blue Square Spectrum 360	N/A



R6 WITH Q500 CAM LOCKS		
Light Model	Dimension	Spare Part
Jacuzzi Q500 Underwater Pool Light	6"	R6 006 Q5 CA



**IMPORTANT:**  
A transformer, such as LVX or LitYard2 system will need to be added when replacing existing high voltage (120V) lights.

# R8 RETRO FITS



## SERIES 8" RETRO LIGHTS

LIGHTS & MOUNTING KIT CHOOSE YOUR LIGHT OPTION, UNIVERSAL ADAPTOR & RIM COLOR			
Pool Type	LED Option	Rim Colour	Product Code
CONCRETE & VINYL POOLS 1x Retro 8" (R8) Light + 8" Niche Adaptor + Plug Seal Assembly Kit + Rim	Multi Plus	White	R8C L12 C1 WMP
		Grey	R8C L12 C1 GMP
	White 4000k	White	R8C L12 C1 WW4
		Grey	R8C L12 C1 GW4
	White 3000k	White	R8C L12 C1 WW3
		Grey	R8C L12 C1 GW3

Will fit existing niches with inner diameter of:

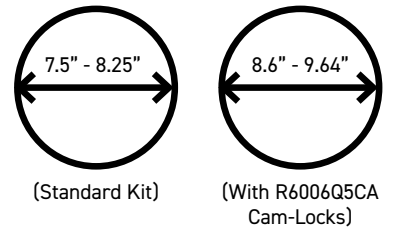

REPLACEMENT BULBS INCLUDES 1X 10" LIGHT		
Pool Type	LED Option	Product Code
CONCRETE & VINYL POOLS	1X Retro 10" (R10) Multi Plus Light	R10 L12 C0 MP
	1X Retro 10" (R10) White 4K Light	R10 L12 C0 W4
	1X Retro 10" (R10) White 3K Light	R10 L12 C0 W3

R8 RETRO-FIT WITH R8 BRACKET		
Light Model	Dimension	Spare Part
Pentair – Sta-Rite SwimQuip Pool Light P/N 78244200 & 78241202  i). P/N 7824200 ii). P/N 78241202	8"	
HAYWARD PROSERIES	8.5"	N/A





# R10 RETRO FITS



## SERIES 10" RETRO LIGHTS

LIGHTS & MOUNTING KIT			
CHOOSE YOUR LIGHT OPTION, UNIVERSAL ADAPTOR & RIM COLOR			
Pool Type	LED Option	Rim Colour	Product Code
<b>CONCRETE &amp; VINYL POOLS</b> 1x Retro 10" (R10) Light + 10" Niche Adaptor + Plug Seal Assembly Kit + Rim	Multi Plus	White	<b>R10C L12 C1 WMP</b>
		Grey	<b>R10C L12 C1 GMP</b>
	White 4000k	White	<b>R10C L12 C1 WW4</b>
		Grey	<b>R10C L12 C1 GW4</b>
	White 3000k	White	<b>R10C L12 C1 WW3</b>
		Grey	<b>R10C L12 C1 GW3</b>

Will fit existing niches with **inner** diameter of:

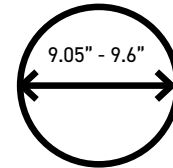

REPLACEMENT BULBS INCLUDES 1X 10" LIGHT		
Pool Type	LED Option	Product Code
<b>CONCRETE &amp; VINYL POOLS</b>	1x Retro 10" (R10) Multi Plus Light	<b>R10 L12 C0 MP</b>
	1x Retro 10" (R10) White 4K Light	<b>R10 L12 C0 W3</b>
	1x Retro 10" (R10) White 3K Light	<b>R10 L12 C0 W4</b>

R10 RETRO-FIT WITH R10 BRACKET		
Light Model	Dimension	Spare Part
IntelliBrite® 5G Color and White LED Pool Lights	10"	N/A
Intellibrite® Architectural Series	10"	N/A
Pentair 78210300 Stainless Steel Niches	10"	N/A
Pentair 79206700 Plastic Niches	10"	N/A
Jandy® Large Stainless Steel ProNiche SSNICLRG1R	10"	N/A
Jandy® Large White Incandescent Light	10" diameter 5.01" depth	N/A



# R10 RETRO FITS (CONTINUED)

## SERIES 10" RETRO LIGHTS

R10 RETRO-FIT WITH R10 BRACKET		
Light Model	Dimension	Spare Part
Jandy® Commercial Large White LED Light	10.04" diameter 3.24" depth	N/A
Pentair Amerlite® Underwater Incandescent Light	10.12" diameter 7.72" depth	
Large Plastic Niche, Gunite Pool Light PLNICLRG	9.85"	
Hayward Large Niche-Gun/Con SS 1/2 REA		
Hayward DuraNiche SPX9607UC/SP0607U (Vinyl)		R10 Vinyl Dress Ring 2
Hayward Plastic Niche - Vinyl Pool SP0508A (Vinyl)		R10 Vinyl Dress Ring 2
Pentair Stainless Steel Niche 78232500 (Vinyl)		R10 Vinyl Dress Ring 3
Pentair Quick Niche ASY 620004 (Vinyl)		R10 Vinyl Dress Ring 1



# R10 RETRO FITS (CONTINUED)

## SERIES 10" RETRO LIGHTS

R10 RETRO-FIT WITH R10 BRACKET		
Light Model	Dimension	Spare Part
Hayward ColorLogic 4.0 LED Pool & Spa Lights	N/A	N/A
J&J Electronics INC. XG-W Series SwimQuip Version Light fits into existing large niches with similar mounting dimensions to Jandy PLNICLRG	N/A	N/A
Pooltone™ Standard 16 Color Led Pool Light	10"	N/A
Jacuzzi Full Moon Pool Light	10 ½"	N/A
Hayward AstroLite Pool Lighting	N/A	N/A
S.R. Smith kēlo®XL Light fits into existing large niches with similar mounting dimensions to Jandy PLNICLRG	10"	N/A



R10H RETRO FIT WITH R10H ADAPTOR		
Light Model	Dimension	Spare Part
Hayward Universal ColorLogic® and CrystaLogic™ (Shallow Niche)	N/A	R10H Adaptor



**Part Numbers for Vinyl Dress Rings:**

R10V0021CAWH - White

R10V0021CAGY - Grey

# COULDN'T FIND THE LIGHT YOU'RE LOOKING FOR?

## FOLLOW THESE SIMPLE STEPS

- 1** Turn off power, remove light from pool wall and measure the opening of niche. Important: Inner dimension of the opening/light housing is needed to confirm the proper fit.
- 2** Still can't find it? Take photos of the existing light and transformer and email [info@selectpoolproducts.ca](mailto:info@selectpoolproducts.ca)
- 3** We are here to help. Call 1-855-881-0889 or email [info@selectpoolproducts.ca](mailto:info@selectpoolproducts.ca). You can also visit [www.selectpoolproducts.ca/retro](http://www.selectpoolproducts.ca/retro) for more information on the Retro Series range.